

UltraBase™

Above-Floor Isolation Kennels

KENNEL

SOLUTIONS PTY LTD

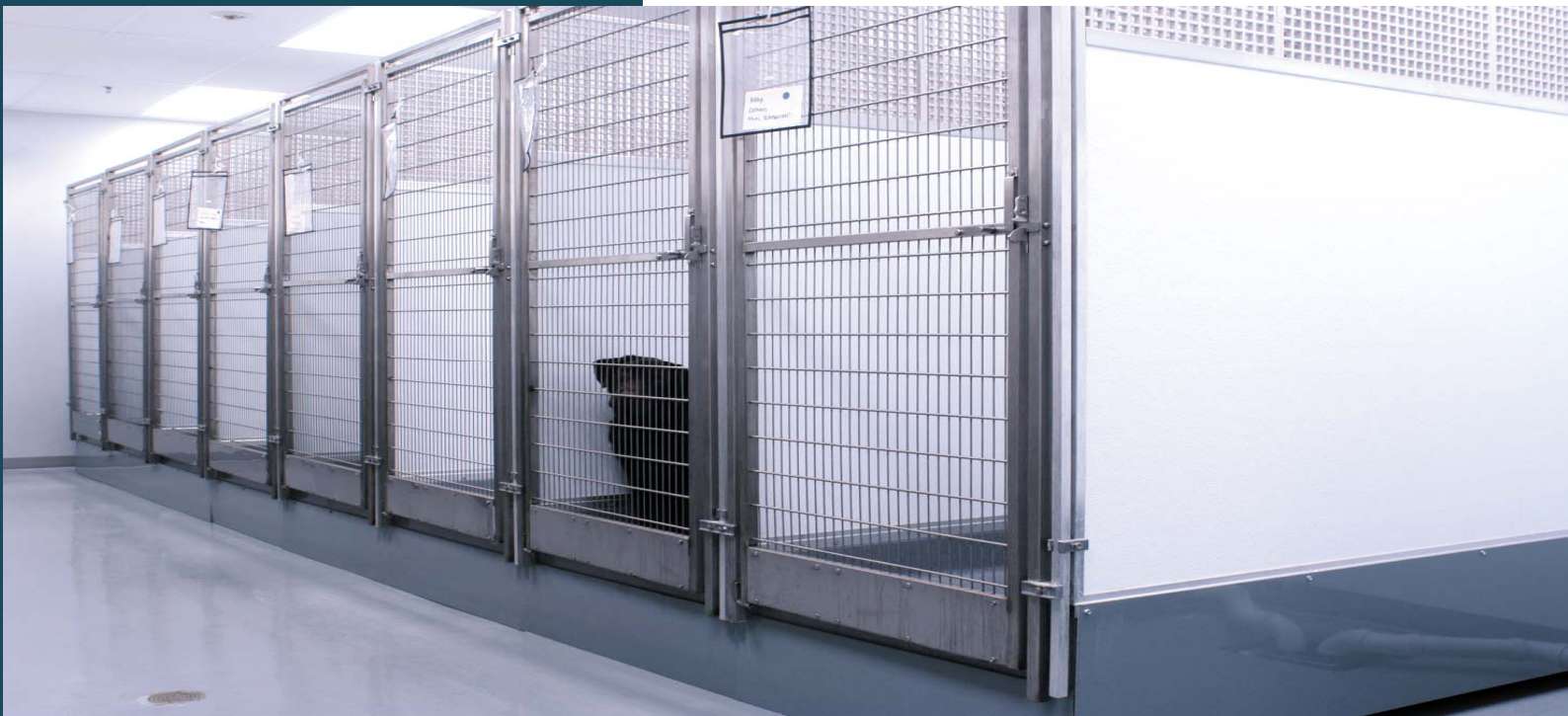

The UltraBase Advantage:

- No gutter or special sewer lines required.
- Kennels can go in spaces not normally designed for animal housing.
- Safe, secure and durable
Easy to clean, too!!

18 Decorator FRP Wall Colours

131

467

233

806

50

484

710

750

000

203

334

525

277

139

698

132

298

293

Stretch your Kennel space!

Go where you didn't think possible with our elevated UltraBase. With no gutter or special sewer lines required, the UltraBase system permits you to install indoor kennels in spaces not normally constructed for housing animals.

The elevated base and on-floor PVC piping routes liquids and wastes to the nearest sewer outlet. The newly redesigned, one-piece composite fibreglass base unit securely attaches to FRP isolation side panels for a watertight seal. UltraBase features an easy-to-clean, anti-slip floor and adjustable legs, allowing for installation on uneven floors.

The UltraBase can be installed as a stand alone unit or in a series, with Chainlink swing gates or our stainless steel gates. Swing-up rest benches, which provide added comfort and permit easy drain access, are optional.



Exclusive distributor throughout Asia Pacific for-



MASON
COMPANY



Trusted Animal Enclosure Solutions — Since 1892

©Copyright 2009 Kennel Solutions Pty Limited.
ABN 82 107 418 262

America's #1 Trusted Animal Enclosure Solutions
Now Available in Australia

For more information:

Contact Kennel Solutions

T: 1800 251 766

E: info@kennelsolutions.com.au

www.kennelsolutions.com.au

UltraBase™ Kennels

UNIT DETAILS & OPTIONS

Material

Base made of moulded composite fibreglass

Available Sizes

- 914mm x 1219mm
- 914mm x 1524mm
- 914mm x 1829mm
- 914mm x 2133mm
- 914mm x 2438mm
- 1219mm x 1219mm
- 1219mm x 1524mm
- 1219mm x 1829mm
- 1219mm x 2133mm
- 1219mm x 2438mm

Standard Features

- One-piece base with vertical side and back Flanges
- Anti Slip Floor Surface
- Adjustable Legs
- Built-in 50mm PVC back floor drain

Options

- See Doors & Accessories insert for details
- Swing-up rest bench
 - Kenl-Dor in division or Back Panel
 - Top Covers

FRP Panels
18 Colour choices

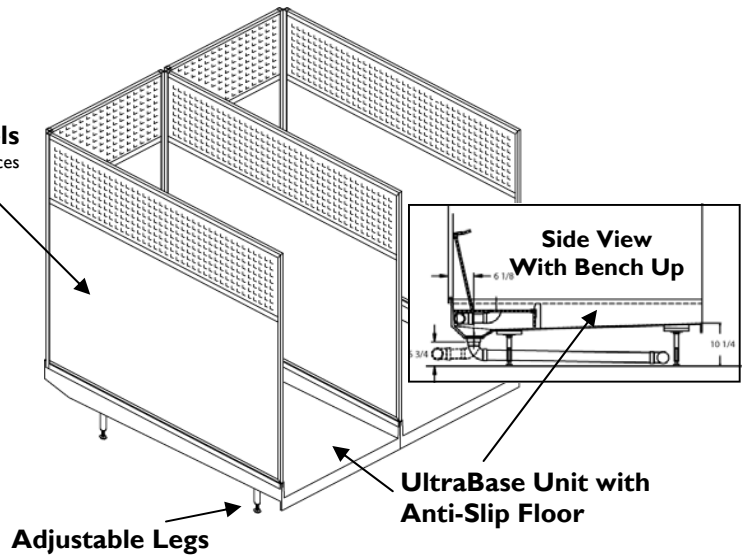

GATES & STALL FRONTS

All of Kennel Solutions gates and stall fronts come pre-hung and completely assembled

Stainless Steel Gates

Available Sizes

Height: 1880mm
Width: 914mm

Stainless Steel Stall Fronts

Available Sizes

Height: 1880mm
Width: 914-1219mm

Chainlink Swing Gates with never-fail latch

Available Sizes

Height: 610 - 2438mm
Width: 914 - 1219mm

- 1880mm high entry frame
- Fixed Bottom Panel
- Single Bowl Insert
 - Double Bowl Insert
 - Two-way Latch

Frame, Grid and Panel

Mounting Frame: 6061-T6 aluminium solid bar
Gate Grid: 304 stainless steel wire,
Vertical .32mm diameter, horizontal .64mm diameter
Optional Solid Section: Tempered glass, FRP, or other sheet
Materials

*Call for additional size
Availability

Options

- Single bowl insert
- Double bowl insert

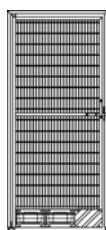

Stainless Steel Swing Gate

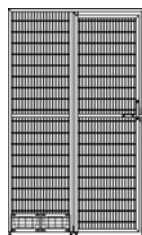

Stainless Steel Stall Front

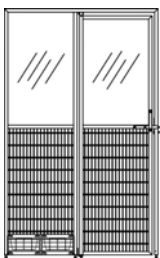

Glass over stainless Combo Stall Front

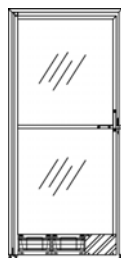

Glass Gate

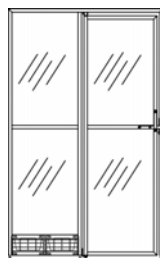

Glass Stall Front

Chainlink Stall Fronts

Required for runs that exceed 1219mm

Available Sizes

Height: 914 - 2438mm
Width: 914 - 1219mm

Options

- All Swing Gate Options
- Gate Location at other end
- See Chainlink Sani-Kennel for other gate options

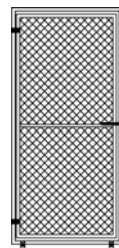

Chainlink Gate

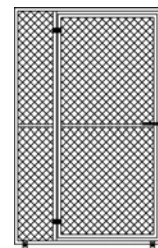

Chainlink Stall Front

TOP COVERS

Dogs stay safe and secure with Kennel Solutions top covers. See the Doors & Accessories Insert for Details

REST BENCHES

Swing-up rest benches keep dogs away from the rear gutter and permit easy cleaning. See the Doors & Accessories Insert for details