

These Unique Features Make the VSSI Cage the Product of Choice for Veterinarians

Sturdier, More Durable Construction

Constructed of a 20 gauge, type 304 polished stainless steel. Heavier gauge stainless steel means less noise and longer life.

Strong, Secure Stainless Steel Door, Latch and Hinge Assembly

Heavy duty door and heavy gauge latch system creates a secure bank of cages.

Formed Threading

Will not cross thread or strip out. Prevents the stainless steel screws, which are self-locking, from loosening with everyday use.

Heavy Duty Reversible Door

One-Piece Stainless Steel Hinge Plate

with multiple attachment points for stability – prevents sagging.

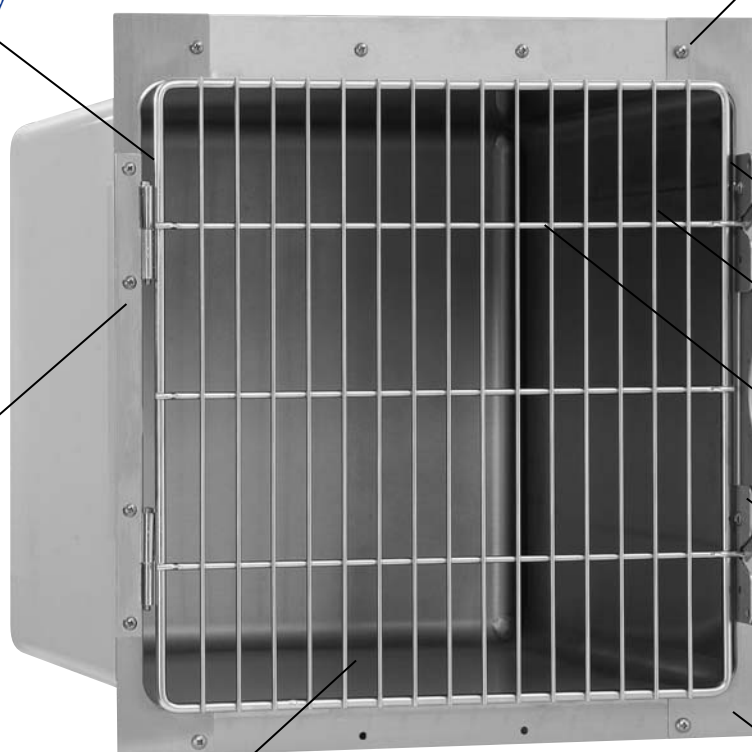

3/8" Diameter Frame

3/16" Diameter Vertical Rods

1/4" Diameter Crossmembers

Latch design allows for padlock or door clip. Extremely quiet and easily cleaned

One-Piece Stainless Steel Corner/Trim Strips

enhances strength and stability – easier to clean.



Full 1" Radius Corners



Fluid Retaining Lip



Built-In Paper Retainer

Resting Shelves Available

Easier To Clean, Less Labor Cost

Larger radius corners and fluid retaining lip make clean-up easier and allows for a much cleaner kennel environment.

Innovative Design Makes VSSI Cages More Durable and Easier to Assemble

All 20 Gauge Stainless Steel Construction



Easier, More Stable Assembly

VSSI's unique "Lap-Lock" overlapping, locking, uniframe mounting system makes assembly much easier and the overall structure more durable.

Multiple 6" centered formed threads within the uniframe system are utilized to securely lock cages together.

Strong Double Door Latch Design

Spring loaded. Secure, yet easy to open and close. No center obstruction.



Shown with optional top panel, side panels, and base.

CAD drawings let you see what you're getting before you get it!

Our sales staff will be happy to advise you in the layout of your animal boarding/holding area. We can provide detailed drawings and dimensions so you can see how your cage configuration will fit your area.

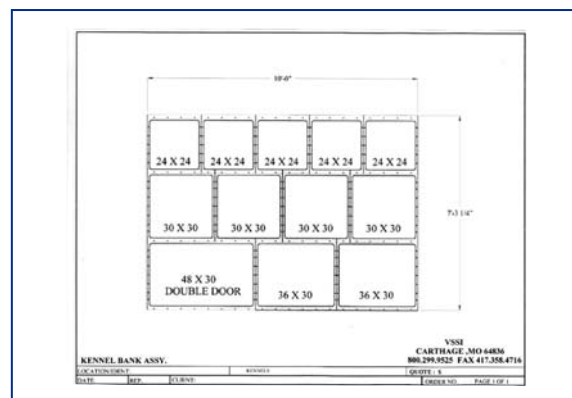

1-800-299-9525

fax 417-358-4716 • www.vssi.com • e-mail vssi@vssi.com

Custom Build Your Configuration with VSSI Modular Cages



VSSI Stainless Steel Cages can be configured in many different ways. Our "Lap Lock" Uniframe System gives you the opportunity to configure your own arrangement. Call today!

Modular Cage Units

- All cages are single door except for the 48"w x 30"h which has a double door.*
- 1" radius corners for easy cleaning
- Heavy 20 gauge, type 304 stainless steel
- Heavy duty stainless steel door for security
- Maximizes animal holding area
- Easily configured
- Completely interchangeable

160-1824-00	18"w x 24"h x 28"d
160-2418-00	24"w x 18"h x 28"d
160-2424-00	24"w x 24"h x 28"d
160-2430-00	24"w x 30"h x 28"d
160-3030-00	30"w x 30"h x 28"d
160-3630-00	36"w x 30"h x 28"d
160-4830-00	48"w x 30"h x 28"d *

Popular Cage Configurations

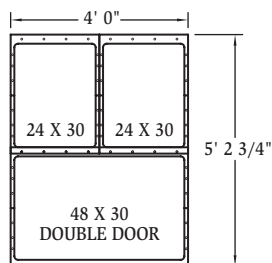

3-Unit Assembly Option 1

Top Row: Two 24"w x 30"h Cages
Bottom Row: One 48"w x 30"h Double Door Cage

160-0103-00 3-Unit Assembly Option 1

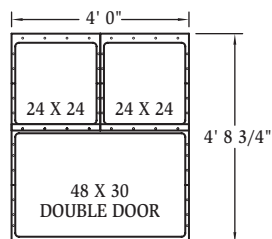

3-Unit Assembly Option 2

Top Row: Two 24"w x 24"h Cages
Bottom Row: One 48"w x 30"h Double Door Cage

160-0103-10 3-Unit Assembly Option 2

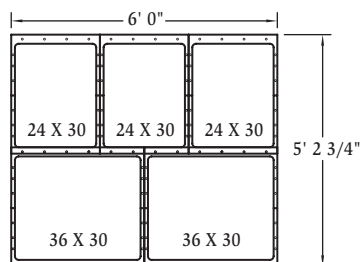

5-Unit Assembly Option 1

Top Row: Three 24"w x 30"h Cages
Bottom Row: Two 36"w x 30"h Cages

160-0105-00 5-Unit Assembly Option 1

Popular Cage Configurations Cont'd.

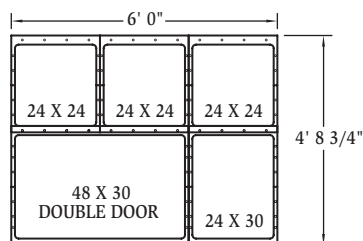

5-Unit Assembly Option 2

Top Row: Three 24" w x 24" h Cages
 Bottom Row: One 48" w x 30" h Double Door Cage
 One 24" w x 30" h Cage

160-0105-10 5-Unit Assembly Option 2

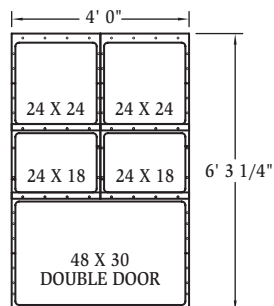

5-Unit Assembly Option 3

Top Row: Two 24" w x 24" h Cages
 Middle Row: Two 24" w x 18" h Cages
 Bottom Row: One 48" w x 30" h Double Door Cage

160-0105-20 5-Unit Assembly Option 3

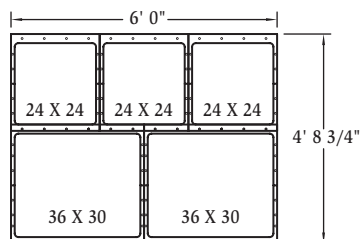

5-Unit Assembly Option 4

Top Row: Three 24" w x 24" h Cages
 Bottom Row: Two 36" w x 30" h Cages

160-0105-30 5-Unit Assembly Option 4

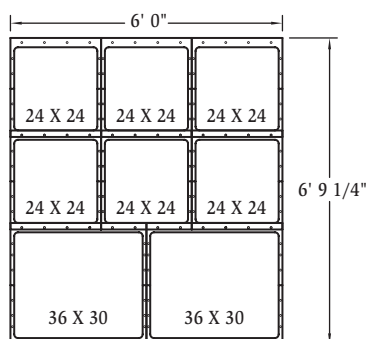

8-Unit Assembly

Top Row: Three 24" w x 24" h Cages
 Middle Row: Three 24" w x 24" h Cages
 Bottom Row: Two 36" w x 30" h Cages

160-0108-00 8-Unit Assembly

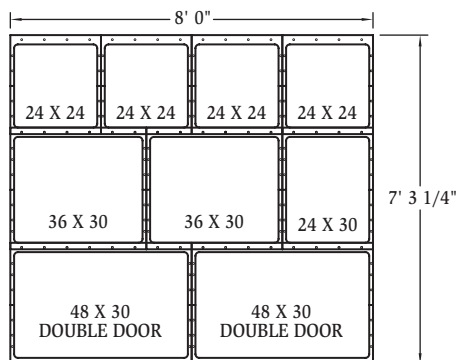

9-Unit Assembly Option 1

Top Row: Four 24" w x 24" h Cages
 Middle Row: Two 36" w x 30" h, One 24" w x 30" h Cages
 Bottom Row: Two 48" w x 30" h Double Door Cages

160-0109-00 9-Unit Assembly Option 1

1-800-299-9525

fax 417-358-4716 • www.vssi.com • e-mail vssi@vssi.com

Popular Cage Configurations Cont'd

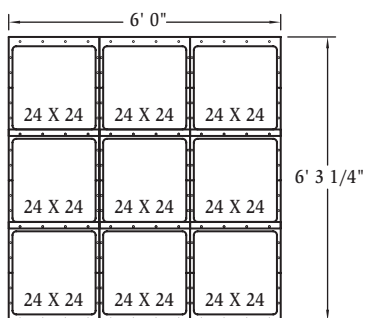

9-Unit Assembly Option 2

Top Row: Three 24"w x 24"h Cages
 Middle Row: Three 24"w x 24"h Cages
 Bottom Row: Three 24"w x 24"h Cages

160-0109-10 9-Unit Assembly Option 2

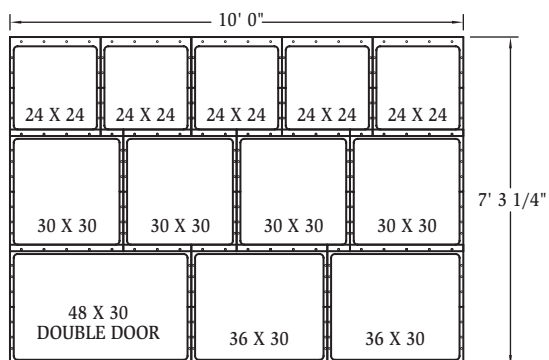

12-Unit Assembly

Top Row: Five 24"w x 24"h Cages
 Middle Row: Four 30"w x 30"h Cages
 Bottom Row: One 48"w x 30"h Double Door Cage
 Two 36"w x 30"h Cages

160-0112-00 12-Unit Assembly

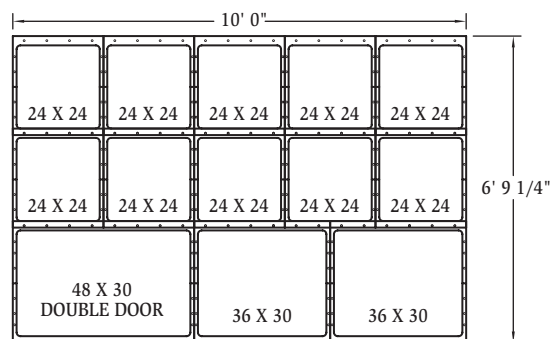

13-Unit Assembly

Top Row: Five 24"w x 24"h Cages
 Middle Row: Five 24"w x 24"h Cages
 Bottom Row: One 48"w x 30"h Double Door Cage
 Two 36"w x 30"h Cages

160-0113-00 13-Unit Assembly

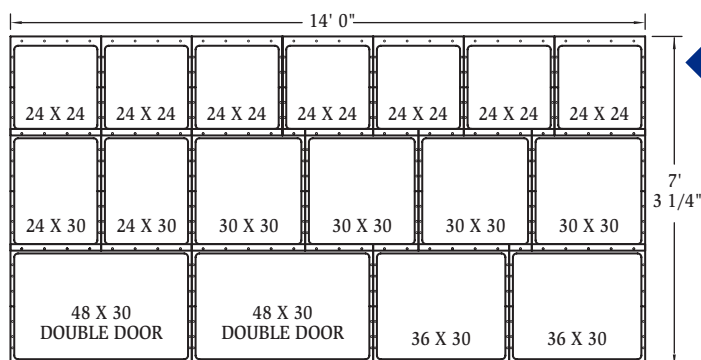

17-Unit Assembly

Top Row: Seven 24"w x 24"h Cages
 Middle Row: Two 24"w x 30"h Cages
 Four 30"w x 30"h Cages
 Bottom Row: Two 48"w x 30"h Double Door Cages
 Two 36"w x 30"h Cages

160-0117-00 17-Unit Assembly

A Full Line of Accessories to Complete Our Stainless Steel Cages



Digital indicator shows temperature and humidity inside the cage

O² Door

- Door can be reversed
- Door made of 1/4" plexiglass with stainless steel frame
- Standard humidifier allows humidification of oxygen. Heat or cool the humidified air by adding ice or heated water to the attachable chamber
- Our competitors use rubber seals which always need to be removed and cleaned
- Door seals against cage without using separate rubber seals
- Digital indicator shows temperature and humidity inside cage
- Nebulizer kit available, call for details

145-2424-00	O2 Therapy Door for 24"w x 24"h VSSI Cage
145-2430-00	O2 Therapy Door for 24"w x 30"h VSSI Cage
145-3030-00	O2 Therapy Door for 30"w x 30"h VSSI Cage
145-3630-00	O2 Therapy Door for 36"w x 30"h VSSI Cage
245-9000-00	Nebulizer Kit (<i>sold separately</i>)



Height: 6"



Height: 6"

Locking Front Casters

Stationary Platform

- Constructed of 12 gauge stainless steel angle
- 7 different lengths available
- 28" depth matches the depth of our cages
- Mounting holes are pre-drilled and ready for accepting cages
- Four leg welded steel platform includes leveling feet and center runner for added support

260-0359-00	18"w Stationary Platform
260-0359-01	24"w Stationary Platform
260-0359-02	30"w Stationary Platform
260-0359-03	36"w Stationary Platform
260-0359-04	48"w Stationary Platform
260-0359-05	60"w Stationary Platform
260-0359-06	72"w Stationary Platform

Mobile Platform

- Same dimensions as our stationary platform
- 4" swivel casters bring easy mobility to a cage unit

260-0359-20	18"w Mobile Platform
260-0359-21	24"w Mobile Platform
260-0359-22	30"w Mobile Platform
260-0359-23	36"w Mobile Platform
260-0359-24	48"w Mobile Platform
260-0359-25	60"w Mobile Platform
260-0359-26	72"w Mobile Platform

1-800-299-9525

fax 417-358-4716 • www.vssi.com • e-mail vssi@vssi.com

Options and Accessories



Side Panel

- Where needed, panels have formed threaded holes to make assembly easy
- 20 gauge stainless steel side panels give the unit a finished look

619-0342-00	Side Panel for 18"h Cage, Right
619-0343-00	Side Panel for 18"h Cage, Left
619-0344-00	Side Panel for 24"h Cage, Right
619-0345-00	Side Panel for 24"h Cage, Left
619-0346-00	Side Panel for 30"h Cage, Right
619-0347-00	Side Panel for 30"h Cage, Left



Top Panel

- Provide added protection against dirt and debris that might settle in between the cage unit
- 20 gauge stainless steel top panels install easily

619-0368-00	Top Panel for 18"w Cage Bank
619-0368-01	Top Panel for 24"w Cage Bank
619-0368-02	Top Panel for 30"w Cage Bank
619-0368-03	Top Panel for 36"w Cage Bank
619-0368-04	Top Panel for 48"w Cage Bank
619-0368-05	Top Panel for 60"w Cage Bank
619-0368-06	Top Panel for 72"w Cage Bank



Center Divider Kit

- Rear Channel support installs in the back of the cage and holds the back of the divider in place
- Top and bottom divider holders install easily and hold the front of the divider in place
- Kit includes everything needed to divide our 48" wide cages into two separate cages
- Constructed of 1/2" high-density polyethylene

260-4830-20	Center Divider Kit
-------------	--------------------



Plastisol™ Coated Cage Floors

- Note: 48" Cages with center divider require two pieces, see below for details
- Plastisol™ Coated cage floors help keep the animal warm, dry and clean
- Designed to give added comfort to patients

616-0363-00	Cage Floor for 24" Cage or 48" Cage w/Divider 21 3/8"w x 3 3/16"h x 27 11/16"d
616-0363-01	Cage Floor for 30" Cage 27 3/8"w x 3 3/16"h x 27 11/16"d
616-0363-02	Cage Floor for 36" Cage 33 3/8"w x 3 3/16"h x 27 11/16"d
616-0363-04	Cage Floor for 48" Cage w/o Divider 45 3/8"w x 3 3/16"h x 27 11/16"d
616-0363-06	Cage Floor for 18" Cage 15 3/8"w x 3 3/16"h x 27 11/16"d

Options and Accessories

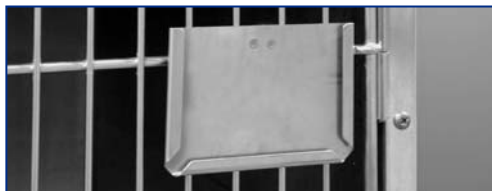

Card Holders

- Two different sizes hold standard 3" x 5" and 5" x 8" cards
- 20 gauge, 304 stainless steel card holder easily installs on cage door

604-0364-00 3" x 5" Stainless Steel Card Holder

604-0364-01 5" x 8" Stainless Steel Card Holder



Clip Boards

- Two sizes available
- 18 gauge, 304 stainless steel boards hang over cross-rods of cage door

260-0500-01 5 1/2" x 7 1/2" Stainless Steel Clip Board

260-0500-02 9" x 12" Stainless Steel Clip Board



Accessory Box

- Constructed of 20 gauge, 304 stainless steel
- Hangs over cross rods of cage door
- Holds toys, medicines, leashes, etc.

260-0501-01 4" x 10" x 4" Stainless Steel Accessory Box



Hinge Mounted IV Rod

- Brings the IV bag conveniently close to the animal without the need of a separate IV stand
- Installs easily on hinge bracket
- Constructed of 1/4", 304 stainless steel rod

620-0362-00 IV Rod Hinge Mount



Stainless Steel Bowls

- Stainless steel construction for durability

834-0000-05 Stainless Steel Bowl, 1/2 Pint

834-0000-06 Stainless Steel Bowl, 1 Pint

834-0000-10 Stainless Steel Bowl, 1 Quart

834-0000-20 Stainless Steel Bowl, 2 Quart



Stainless Steel Bowl Brackets

- Bowl ring construction allows bowl to sit flush and level in bowl bracket
- Special bracket feature holds bowl edge to minimize tip over
- Attaches to vertical bars on cage door

260-0377-05 Stainless Steel Bowl Bracket for 1/2 Pint Bowl

260-0377-06 Stainless Steel Bowl Bracket for 1 Pint Bowl

260-0377-10 Stainless Steel Bowl Bracket for 1 Quart Bowl

260-0377-20 Stainless Steel Bowl Bracket for 2 Quart Bowl

Bowl ring is 1/4" stainless steel rod
Bowl bracket is 14 gauge stainless steel

1-800-299-9525

fax 417-358-4716 • www.vssi.com • e-mail vssi@vssi.com